



HOW TO READ A MODEL NUMBER

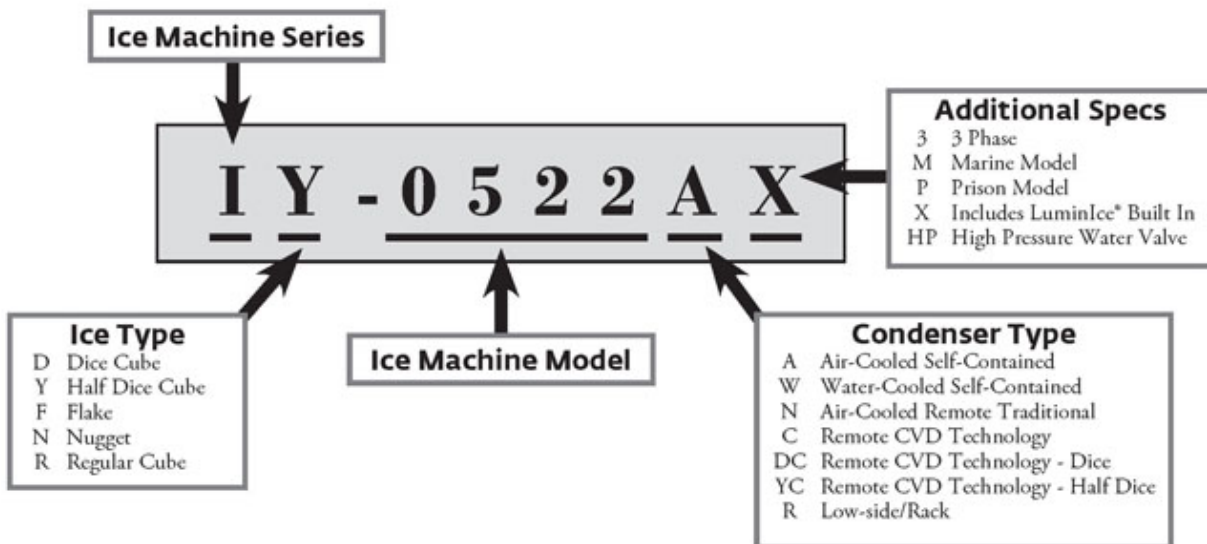

TABLE OF CONTENTS

Manitowoc Foodservice [Updated: Apr. 23, 2015]

Manitowoc - Ice & Related

Parts Catalog

Ice Machine

Indigo Series

Indigo Model - Air, Water & Remote

i0522 Indigo

i0522 Control Box Components 1

i0522 Evaporator Compartment - Common Components 3

i0522 Refrigeration Compartment - Common Parts 6

i0522 Refrigeration Compartment - Air-cooled 9

i0522 Refrigeration Compartment - Water-cooled 11

i0522 Panels 13

i0522 Indigo

I0522 CONTROL BOX COMPONENTS

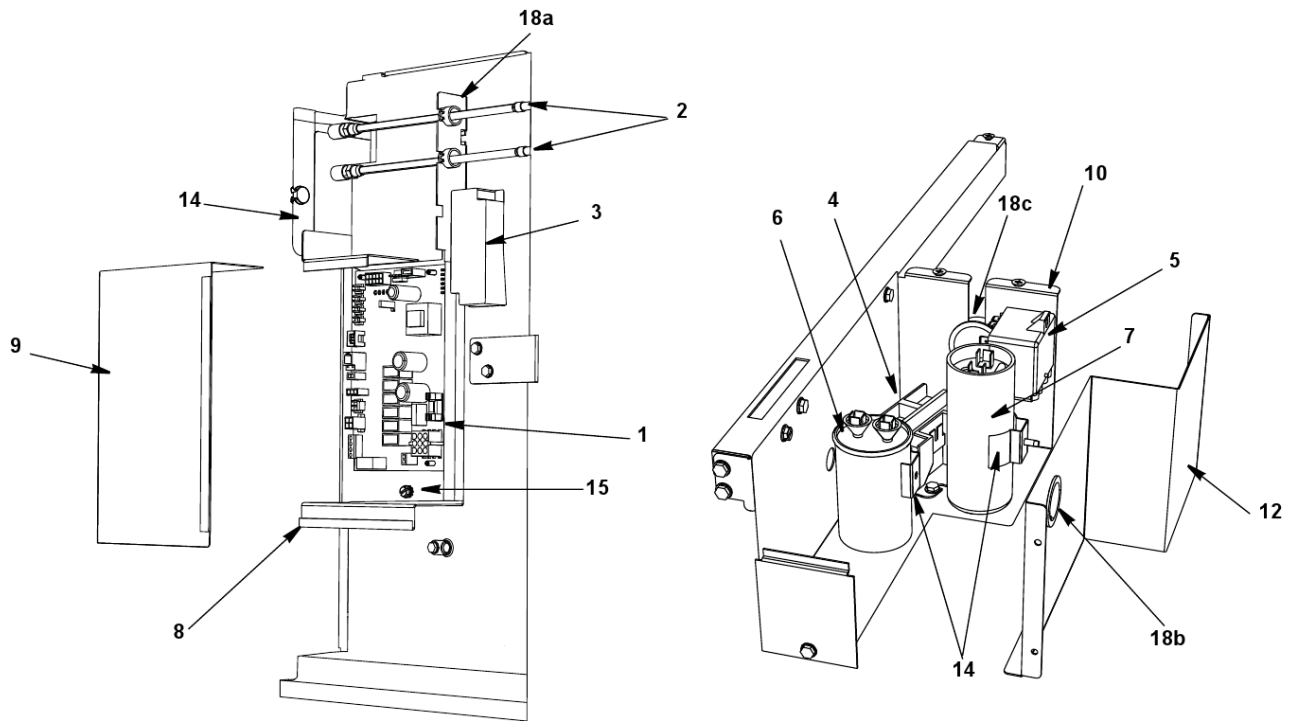

i0522 Indigo

I0522 CONTROL BOX COMPONENTS

#	PART #	DESCRIPTION	QTY	Note
1	000008309	Control Board		
1a	000009181	8 amp Ceramic Fuse - Mounted on Control Board		
2	8373263	Refrigeration Service Valve Assembly		
3	K00424	LuminIce		
4		Contactora		
4a	2006589	Contactora - 115V/60 Hz/1 Ph		
4b	2006599	Contactora - 230V/50-60 Hz/1 Ph		
5		Start Relay		
5a	2002053	Start Potential Relay - 115V/60 Hz/1 Ph		
5b	2007929	Start Potential Relay - 208-230V/50-60 Hz/1 Ph		
6		Run Capacitor		
6a	2010143	Run Capacitor - 115V/60 Hz/1 Ph		
6b	000007675	Run Capacitor - 208-230V/50-60 Hz/1 Ph		
6c	8504003	Run Capacitor - 208-230V/50-60 Hz/1 Ph		
7		Start Capacitor		
7a	8505773	Start Capacitor - 115V/60 Hz/1 Ph		
7b	8503833	Start Capacitor - 208-230V/50-60 Hz/1 Ph		
8	000009213	Control Board Box		
9	000009228	Control Board Box Cover		
10	000008623	Start Components Box		
11	6069681	Start Components Box Top Cover		
12	000008620	Start Components Box Side Cover		
13	4302253	Control Board Mounting Supports		
14	5005303	Capacitor Mounting Brackets		
15	5202169	Screw - #10-24 x 0.50" Ground		
15a	5573209	Star Washer		
16	5202069	Screw - #10-24 x 0.50" HEX		
17	5573209	Star Washer		
18		Control Box Bushings		
18a	2502189	Bushing - 0.625"		
18b	2500019	Bushing - 1.187"		
18c	2500139	Bushing - 1.5"		
19		Control Box Wiring Harness		
19a	000007839	Control Box Wiring Harness - 115V/60 Hz/1 Ph		
19b	000007840	Control Box Wiring Harness - 230V/60 Hz/1 Ph		
19c	000007841	Control Box Wiring Harness - 230V/50 Hz/1 Ph		
20	2008529	Compressor Compartment Wiring Harness		

i0522 Indigo

I0522 EVAPORATOR COMPARTMENT - COMMON COMPONENTS

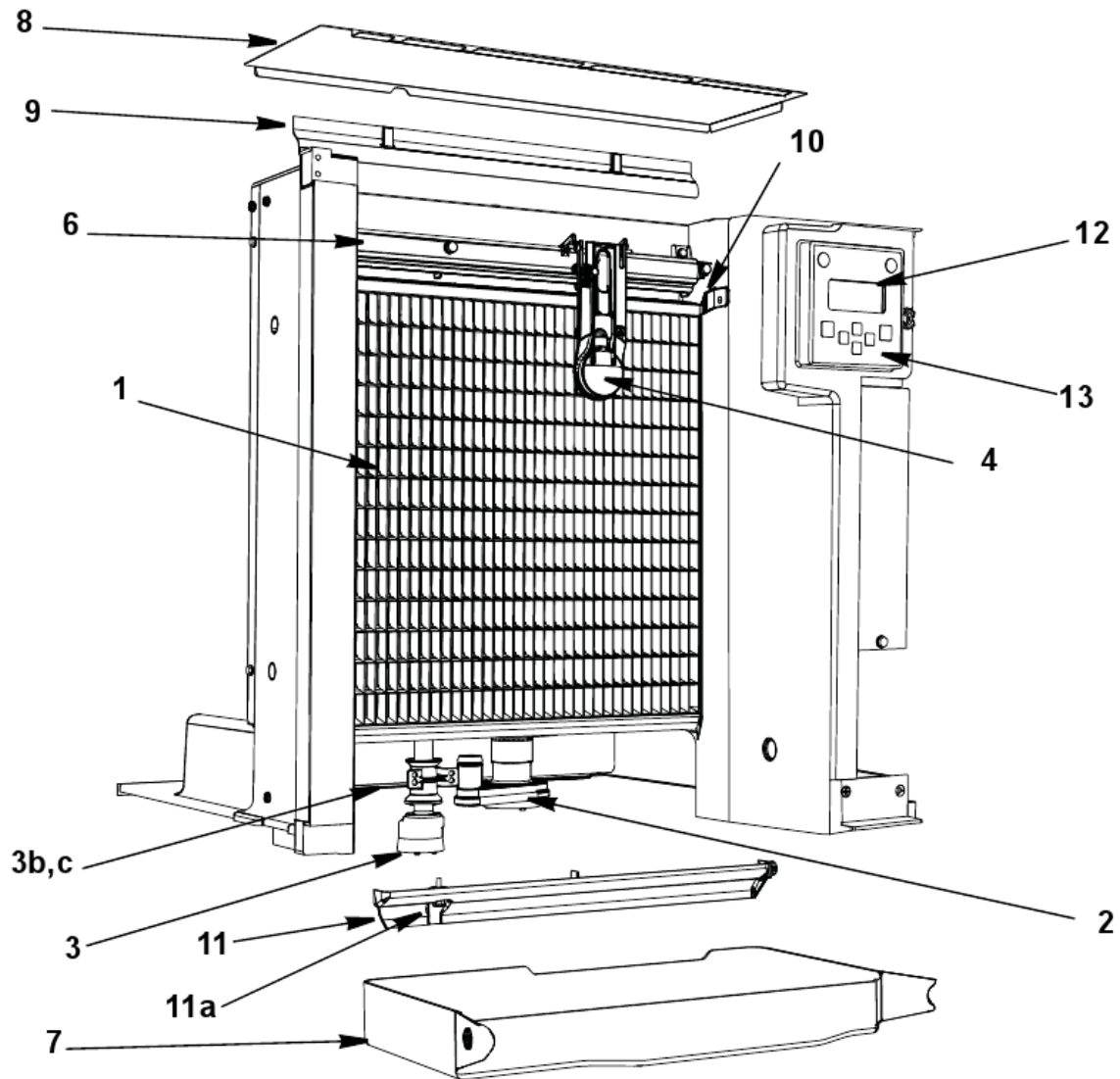

I0522 EVAPORATOR COMPARTMENT - COMMON COMPONENTS

#	PART #	DESCRIPTION	QTY	Note
1		Evaporator Assembly		
1a	000011339	Evaporator - Dice Cube		
1b	000011340	Evaporator - Half Dice Cube		
1c	000011341	Evaporator - Regular Cube		
2		Water Pump		
2a	2008929	Water Pump - 115V/60 Hz		
2b	2008939	Water Pump - 230V/60 Hz		
2c	2008949	Water Pump - 230V/50 Hz		
2d	000010244	Water Pump Mount		
3	000007052	Water Level Probe		
3a	000007099	Wire - Control Box to Probe		
3b	000007053	Water Level Probe - Holder		
3c	5202099	Screw - #10-24 x 0.50" PHIL		[1]
4	000008660	Ice Thickness Control Probe		
5	4011189	Water Curtain		
6	7602789	Water Distribution Tube - 22" L		
6a	5004649	O-Rings		[2]
7		Water Trough		
7a	4009149	Water Trough - without Tabs		[3]
7b	000010336	Water Trough - with Tabs		[4]
8	000009188	Foodzone Seal Panel		
9	6065389	Evaporator Top Filler Panel		
9a	6063339	Bracket - Top Filler Panel		
9b	5202099	Screw - #10-24 x 0.50" PHIL		
10	7602799	Evaporator Top Frame Assembly		
11	7602779	Water Diverter - 22" Models		
11a	5305123	Thumbscrew SS - #8-32 x 0.44"		
12	000006728	LCD Display		
13	000008064	Touch Pad with Housing		
14	000007828	LCD Wiring Harness - 20" Long		
15	000006697	Touch Pad/Housing Mounting Bracket		
16		Front Panel LCD Frame		
16a	000007046	Front Panel LCD Frame with Key Guard		
16b	000007047	Front Panel LCD Frame without Key Guard		
16c	K00433	Display Cover		[5]
17	5004799	Thumbscrew SS - #8-32 x 0.375"		[6]
17a	5004629	O-Ring - 0.125" ID		
18	5004619	Screw - #12-16 x 0.687"		
19	5004659	Water Pump Base O-Ring - 4.00" ID		
20	5004679	Water Pump Outlet O-Ring - 0.875" ID		

PART NOTES:

- [1] - Mount Water Level Probe Holder
- [2] - Back of Distribution Assembly
- [3] - \water trough.jpg" width=311 height=143>

I0522 EVAPORATOR COMPARTMENT - COMMON COMPONENTS

PART NOTES:

- [4] - \water trough with tabs.jpg" width=355 height=194>
- [5] - hides the display completely
- [6] - Water Distribution Tube Mounting

I0522 REFRIGERATION COMPARTMENT - COMMON PARTS

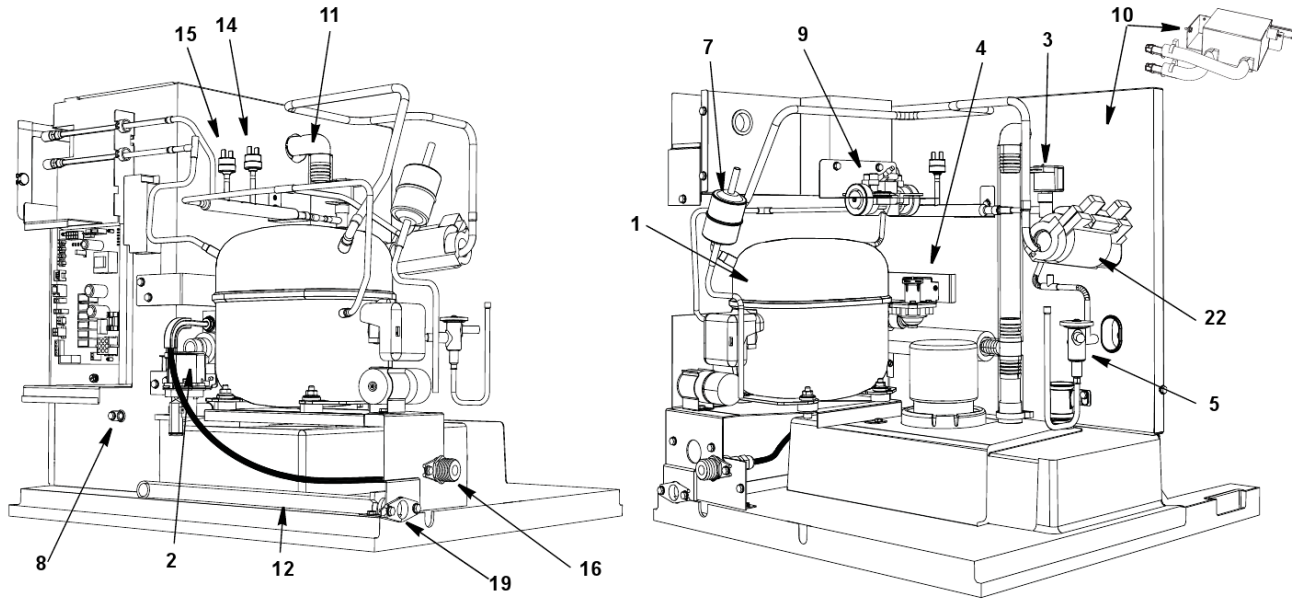

i0522 Indigo

I0522 REFRIGERATION COMPARTMENT - COMMON PARTS

#	PART #	DESCRIPTION	QTY	Note
1		Compressor		
1a	000003919	Compressor - Danfoss SC15MLX.2 - 115V/60 Hz/1 Ph		
1b	000003920	Compressor - Danfoss SC15MLX.2 - 208-230V/50-60 Hz/1 Ph		
1c	8251403	Overload - 115V/60 Hz/1 Ph		
2		Water Dump Valve		[1]
2a	000001767	Water Dump Valve - 115V/60 Hz		
2b	000001768	Water Dump Valve - 208-230V/50-60 Hz		
2c	6058459	Water Dump Valve Mounting Bracket		
2d	4420383	Clear Tubing - 0.625" ID		
3		Harvest Valve		
3a	000007029	Harvest Valve Including 115V/60 Hz Electrical Coil		
3b	000005156	Danfoss Solenoid Valve Coil Only - 115V/60 Hz		[2]
3c	000007028	Harvest Valve Including 208-230V / 50-60 Hz Electrical Coil		
3d	000005157	Danfoss Solenoid Valve Coil Only - 230V/50-60 Hz		[3]
4		Water Inlet Valve with Bracket		
4a	000009120	Water Inlet Valve - 115V/60 Hz/1 Ph		
4b	000009126	Water Inlet Valve - 208-230V/50-60 Hz		
5	7602903	Expansion Valve		
5a	4000363	Valve Insulation Boot - Body		[4]
5b	4007203	Valve Insulation Boot - Bulb		[5]
6	000008310	Thermistor with Spring Clips		
7	8930259	Drier		
8	000007888	Magnetic Bin Switch		
8a	000007410	Bin Switch Wiring Harness		
9		Air Assist		
9a	000007222	Air Assist - 115V/60 Hz		
9b	000007223	Air Assist - 230V/50-60 Hz		
9c	4011739	Air Manifold		[6]
9d	000006489	Air Assist Bracket		
9e	3001453	Air Assist - Nozzle		
10	K00424	LuminIce		
10a	K00425	LuminIce Bulb		
10b	000007409	LuminIce Wiring Harness		
10c	000007990	Bulkhead Fitting 2.25"		
10d	000008269	Bulkhead Fitting 2.75"		
11	000010896	Insulated Tube		[7]
11a	5650609	Snap Clamp - 1.0" ID		
11b	5650709	Snap Clamp - 0.799"/0.899" ID		
12	000001382	Vinyl Tubing 0.625" ID		[8]
12a	6038831	Insulation 0.88 ID X 0.25W X 13.50L		
12b	5650709	Snap Clamp - 0.799"/0.899" ID		
13	000008364	Manifold Strainer		
13a	6058571	Bracket		
14	2001243	HPCO		
15	2001263	Fan Cycling Control - 200-250 psig		[9]

i0522 Indigo

I0522 REFRIGERATION COMPARTMENT - COMMON PARTS

#	PART #	DESCRIPTION	QTY	Note
16	8706093	Female Wing Adapter - 0.375"		
16a	1360961	Male Connector		
17	4010439	Tubing - Water Inlet Valve		[10]
17a	00000288	Clip-on Tubing Elbow		[11]
18	1360989	Connector - Water Inlet Valve		
19	8706133	Female Wing Adapter - 0.50"		
20		Compressor Mounting		
20a	6060269	Compressor Mounting Base		[12]
20b	000010473	Compressor Mounting Base		[13]
20c	8503069	Mounting - Rubber Grommet		
20d	8503949	Mounting - Sleeve		
20e	5004819	Compressor Mounting - Bolt		
20f	5004829	Compressor Mounting - Nut		
21	5650529	Clamp - Expansion Valve Bulb		
22	3000503	Strap - Expansion Valve Bulb - 0.5"		
23	5202069	Screw - #10-24 x 0.50" HEX		

PART NOTES:

- [1] - with bracket
- [2] - \pages from 000005156_02.jpg" width=280 height=256>
- [3] - \pages from 000005156_02.jpg" width=266 height=183>
- [4] - \400036_05.jpg" width=2436 height=1463>
- [5] - \pages from 400720_08.jpg" width=923 height=583>
- [6] - Air Pump Tubing Outlet
- [7] - vinyl tubing from distribution tube to water pump & dump valve
- [8] - dump valve to drain adapter
- [9] - \pages from 200126_09.jpg" width=150 height=306>
- [10] - \pages from 401043_05.jpg" width=1797 height=2238>
- [11] - \pages from 000000288_01.jpg" width=228 height=183>
- [12] - Use on Machines Manufactured Before 7/13
- [13] - Use on Machines Manufactured After 7/13

i0522 Indigo

I0522 REFRIGERATION COMPARTMENT - AIR-COOLED

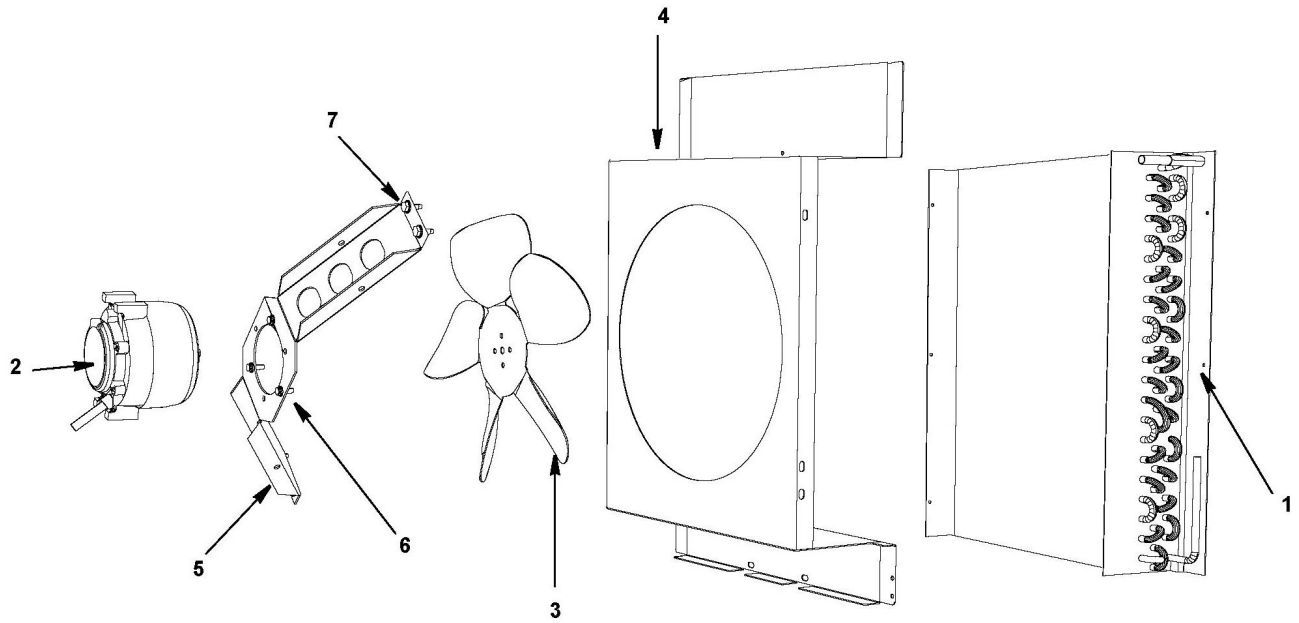

i0522 Indigo

I0522 REFRIGERATION COMPARTMENT - AIR-COOLED

#	PART #	DESCRIPTION	QTY	Note
1	8252129	Air Condenser		
2		Fan Motor		
2a	2412929	Fan Motor 115V/60 Hz/1 Ph		
2b	2412939	Fan Motor 208-230V/50-60 Hz		
3	2416203	Fan Blade		
4	6061689	Fan Shroud		
5	6061869	Fan Motor Bracket		
6	5033589	Mounting - Screw		
6a	5545109	Lockwasher		
6b	5429529	Mounting - Hexnut		
7		Fan Bracket Mounting		
7a	5202099	Screw - #10-24 x 0.50" PHIL		
7b	5545109	Lockwasher		
7c	5573059	Mounting - Flatwasher		
7d	5429559	Mounting - Rubber Wellnut		
8	5202069	Screw - #10-24 x 0.50" HEX		

i0522 Indigo

I0522 REFRIGERATION COMPARTMENT - WATER-COOLED

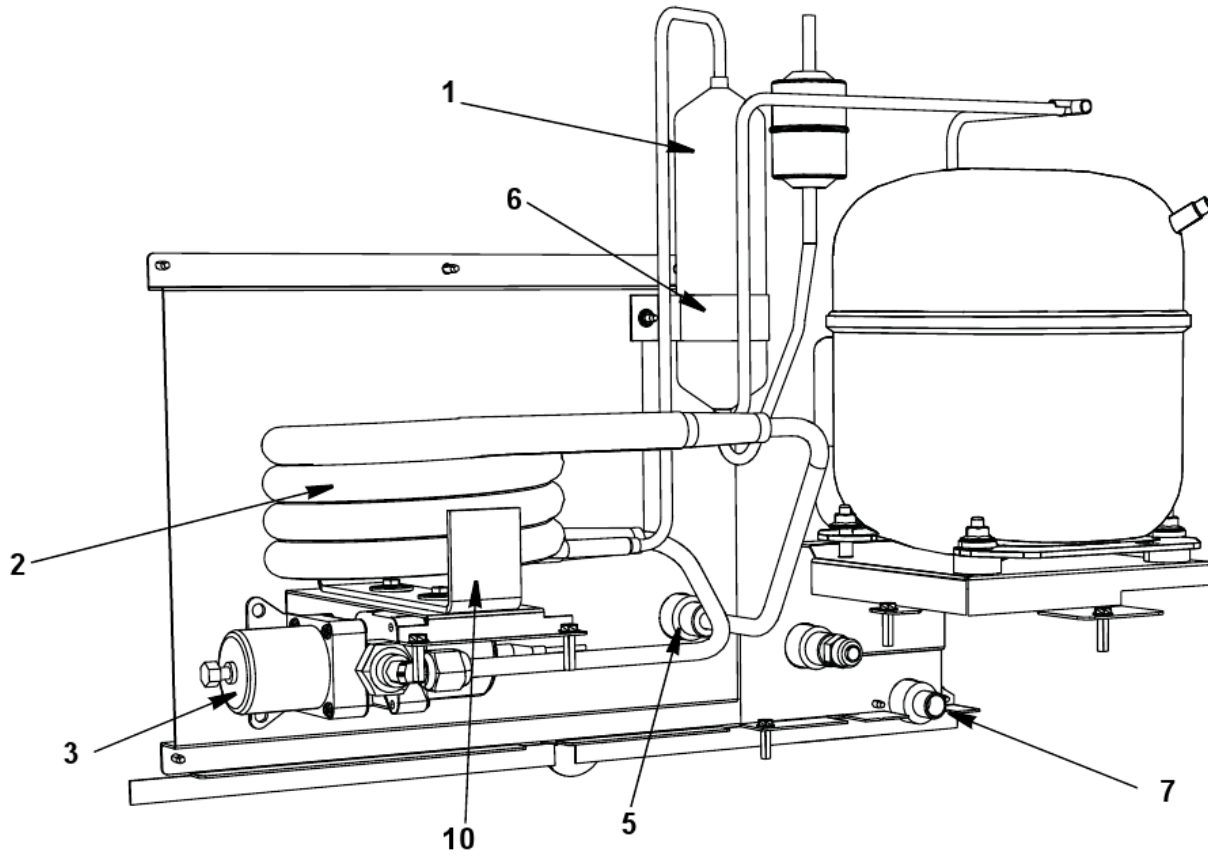

i0522 Indigo

I0522 REFRIGERATION COMPARTMENT - WATER-COOLED

#	PART #	DESCRIPTION	QTY	Note
1	000008892	Receiver		
2	000000046	Water-cooled Condenser		
3	000007546	Water Regulating Valve		
3a	000007695	Bracket - Water Regulating Valve		
4	000007553	Water Regulating Valve - High Pressure		
4a	000008482	Panel - Water Regulating Valve - High Pressure		
5	8706083	Female Wing Adapter - 0.50"		
6	6000541	Receiver Strap		
7	5002159	Elbow 3/8 MF x 3/8 MPT		
8	5202069	Screw - #10-24 x 0.50" HEX		
9	5573419	Washer		
10	6058659	Base, Water Condenser/Receiver		

i0522 Indigo

I0522 PANELS

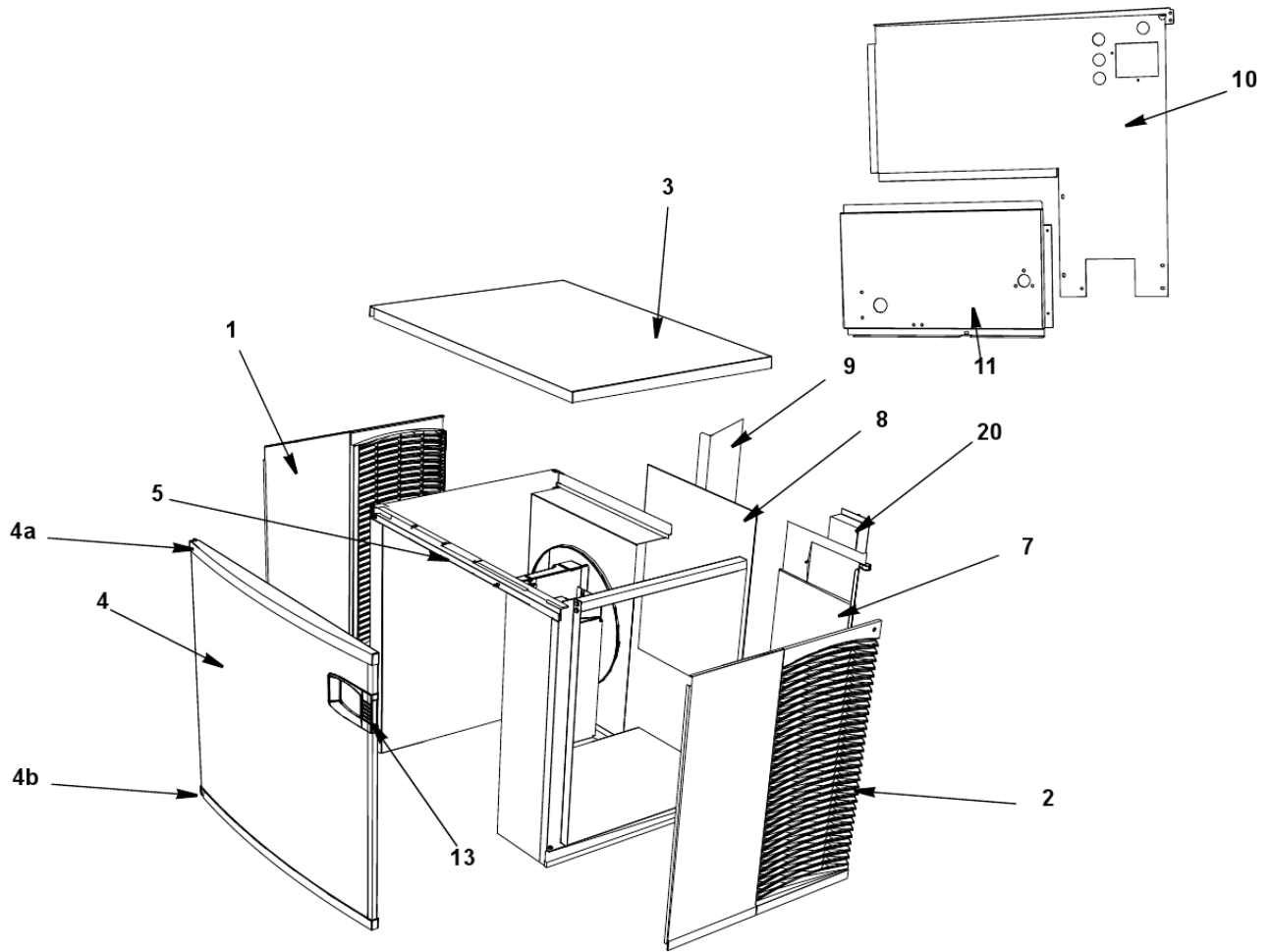

i0522 Indigo

I0522 PANELS

#	PART #	DESCRIPTION	QTY	Note
1	000005217	Left Side Panel		
2	000005215	Right Side Panel		
3	4012029	Top Cover		
4	000006579	Front Panel Assembly		
4a	000006560	Front Panel Top Endcap		
4b	000006565	Front Panel Bottom Endcap		
5	000010050	Front Top Support		
5a	5005379	Mounting Screw - #8-32 x 1.0" PHIL		
5b	5005099	Screw - #10-16 x 0.625"		
		Air-cooled Back Panels		
7	000008621	Back Panel with Electrical Connection Box, Air-cooled Models		
8	3005939	Air Filter		
9	000007314	Air Baffle Assembly		
		Water-cooled Back Panels		
10	000008622	Back Panel with Electrical Connection Box		
11	000008022	Back Coupling Panel, Water-cooled Connections		
12	8706083	Female Wing Adapter - 0.50"		
13		Front Panel LCD Frame		
13a	000007046	Front Panel LCD Frame with Key Guard		
13b	000007047	Front Panel LCD Frame without Key Guard		
13c	K00433	Display Cover		[1]
14	5004899	Front Door Screw		
15	7602829	Bottom Door Frame		
15a	5005379	Mounting Screw - #8-32 x 1.0" PHIL		
15b	5202099	Screw - #10-24 x 0.50" PHIL		
16	3005579	Left Door Pivot Leaf Hinge		[2]
16a	5005379	Mounting Screw - #8-32 x 1.0" PHIL		
17	6068649	Left Top Channel		
18	6071451	Right Top Channel		
19	6062939	Left Corner Post		[3]
19a	000010299	Left Corner Post		[4]
20		Electrical Box on Rear of Ice Machine		
20a	6067289	Rear Connection Box		
20b	6067299	Cover - Rear Connection Box		
20c	2006143	Terminal Block - 50 Hz - 3 Pole		
20d	5202169	Screw - #10-24 x 0.50" Ground		
21	7112319	Cartoning		

PART NOTES:

- [1] - hides the display completely
- [2] - Top or Bottom
- [3] - Use on Machines Manufactured Before 7/13
- [4] - Use on Machines Manufactured After 7/13